

Polycom[®] V VX[®]
Expansion ModulePolycom[®] V VX[®] Color
Expansion Module

Package Contents

Note: The package will contain either a V VX Expansion Module, or a V VX Color Expansion Module.

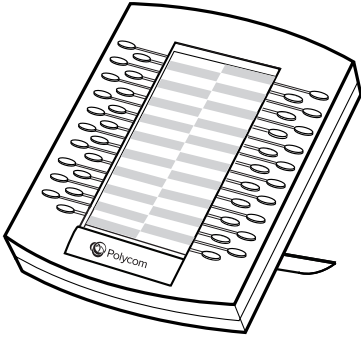
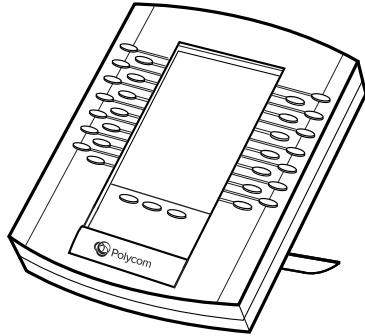
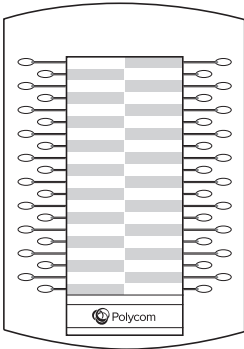

V VX Expansion Module

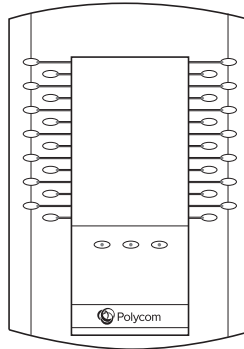

V VX Color Expansion Module

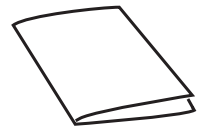

Quick Start Guide

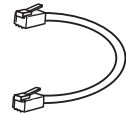

Cable Connector

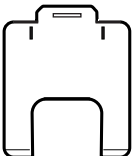

Base Stand



Metal Bracket



Two Thumb Screws

VVX Expansion Module Features

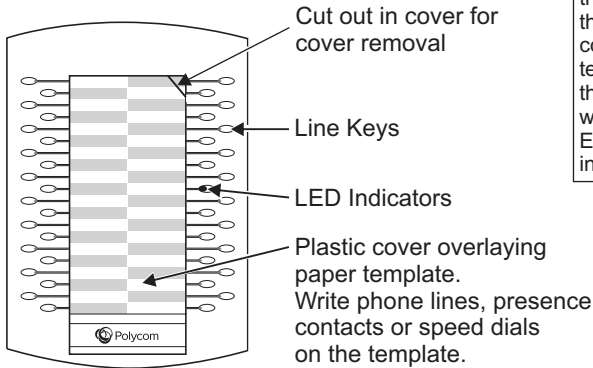

Note: The paper module has a plastic cover that overlays a paper template. To remove or insert the template, place the tip of a paperclip under the slot at the top-right corner of the cover, lift the cover off, and remove or insert the template. To re-attach the cover, align the six tabs on either side of the cover with the corresponding indents on the Expansion Module, and bend the cover into place.

VVX Color Expansion Module Features

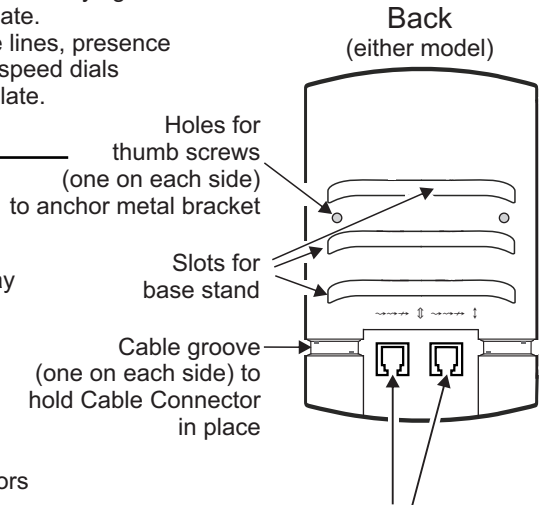
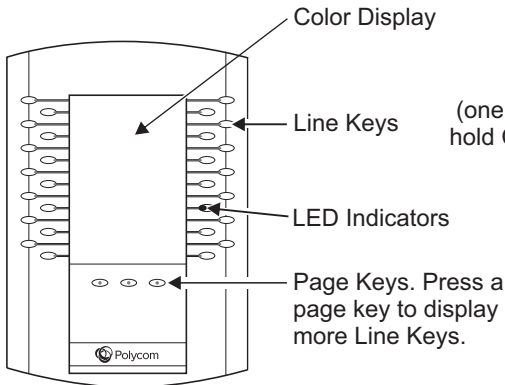

Auxiliary Ports. Connect the Cable Connector to one of these ports, and to an Auxiliary Port on the phone or another Expansion Module.

Connecting the Base Stand*

Fully insert the stand into one of the slots on the back of the Expansion Module. The slot you choose determines the angle of the Expansion Module. The phone and Expansion Module should be at the same angle.

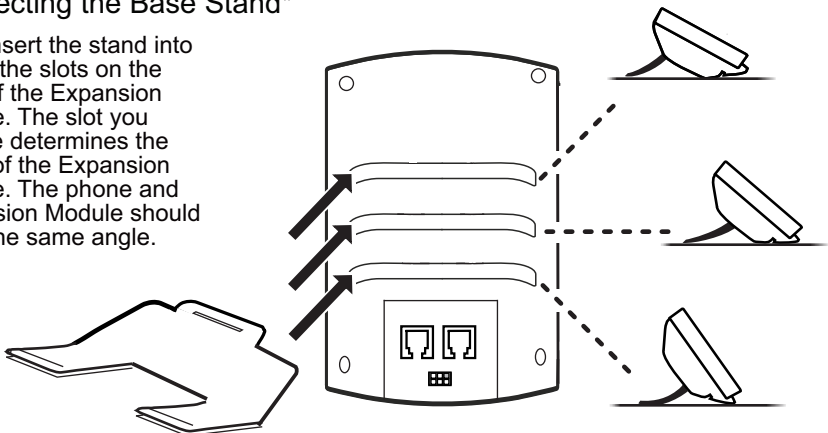

*For wallmount installation, an optional accessory is available. For more information, contact your reseller.

Installing and Starting Up

- 1 Connect the base stand to your Expansion Module at the same angle as your phone's stand.
- 2 Position the phone and Expansion Module next to each other on a flat, level surface. Position them as closely together as you can. Then, locate the holes for the thumb screws; the holes are located between the top-most and middle stand slot.

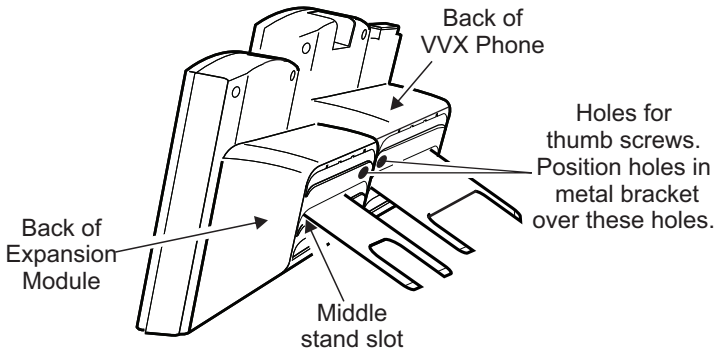

- 3 Hold the metal bracket so that the four tabs face away from you, and the arrow on the back of the bracket points up. Position the holes in the metal bracket over the thumb screw holes. The four tabs on the bracket fit in the top-most and middle stand slots. Insert the thumb screws in the holes, and finger tighten.

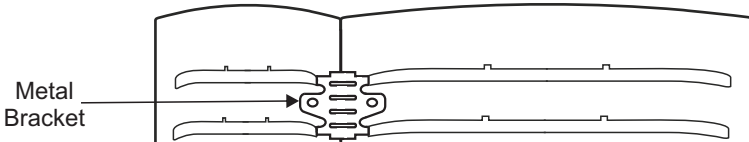

- 4 Turn the phone and Expansion Module upside down on the table. Insert the Cable Connector between the AUX port on the phone, and the AUX 1 port on the Expansion Module. Thread the cable through the Cable Grooves on the Expansion Module and phone. If the phone is connected to the network, the Expansion Module will automatically power on and start up.

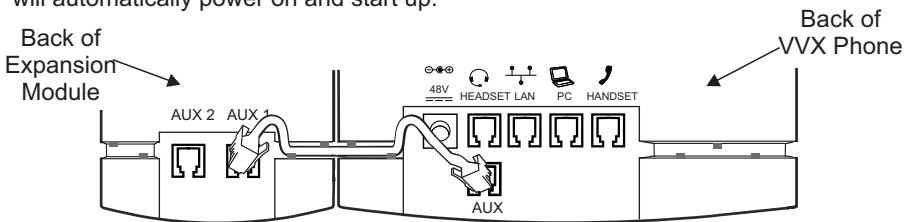

- 5 To connect another Expansion Module, attach another Cable Connector between the AUX 2 port on the first Expansion Module and the AUX 1 port on the second Expansion Module. You can connect a maximum of three Expansion Modules to one phone, as shown next.

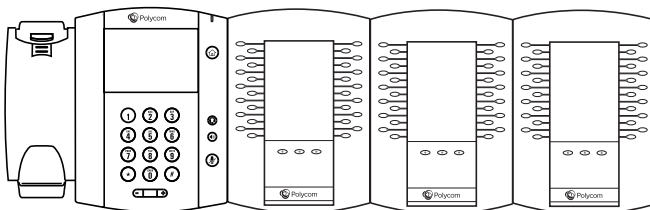

Copyright, Safety Notices

LIMITED WARRANTY. Polycom warrants to the end user ("Customer") that this product will be free from defects in workmanship and materials, under normal use and service, for one year from the date of purchase from Polycom or its authorized reseller. Polycom's sole obligation under this express warranty shall be, at Polycom's option and expense, to repair the defective product or part, deliver to Customer an equivalent product or part to replace the defective item, or if neither of the two foregoing options are reasonably available, Polycom may, on its sole discretion, refund to Customer the purchase price paid for the defective product. All products that are replaced will become the property of Polycom. Replacement products or parts may be new or reconditioned. Polycom warrants any replaced or repaired product or part for ninety (90) days from shipment, or the remainder of the initial warranty period, whichever is longer. Products returned to Polycom must be sent prepaid and packaged appropriately for safe shipment, and it is recommended that they be insured or sent by a method that provides for tracking of the package. Responsibility for loss or damage does not transfer to Polycom until the returned item is received by Polycom. The repaired or replaced item will be shipped to Customer, at Polycom's expense, not later than thirty (30) days after Polycom receives the defective product, and Polycom will retain risk of loss or damage until the item is delivered to Customer.

EXCLUSIONS. Polycom will not be liable under this limited warranty if its testing and examination disclose that the alleged defect or malfunction in the product does not exist or results from:

- Failure to follow Polycom's installation, operation, or maintenance instructions.
- Unauthorized product modification or alteration.
- Unauthorized use of common carrier communication services accessed through the product.
- Abuse, misuse, negligent acts or omissions of Customer and persons under Customer's control; or
- Acts of third parties, acts of God, accident, fire, lightning, power surges or other causes.

WARRANTY EXCLUSIVE. IF A POLYCOM PRODUCT DOES NOT OPERATE AS WARRANTED ABOVE, CUSTOMER'S SOLE REMEDY FOR BREACH OF THAT WARRANTY SHALL BE REPAIR, REPLACEMENT, OR REFUND OF THE PURCHASE PRICE PAID, AT POLYCOM'S OPTION, TO THE FULL EXTENT ALLOWED BY LAW, THE FOREGOING WARRANTIES AND REMEDIES ARE EXCLUSIVE AND ARE IN LIEU OF ALL OTHER WARRANTIES, TERMS, OR CONDITIONS, EXPRESS OR IMPLIED, EITHER IN FACT OR BY OPERATION OF LAW, STATUTORY OR OTHERWISE, INCLUDING WARRANTIES, TERMS, OR CONDITIONS OF MERCHANTABILITY, FITNESS FOR A PARTICULAR PURPOSE, SATISFACTORY QUALITY, CORRESPONDENCE WITH DESCRIPTION, AND NON-INFRINGEMENT, ALL OF WHICH ARE EXPRESSLY DISCLAIMED. POLYCOM NEITHER ASSUMES NOR AUTHORIZES ANY OTHER PERSON TO ASSUME FOR IT ANY OTHER LIABILITY IN CONNECTION WITH THE SALE, INSTALLATION, MAINTENANCE OR USE OF ITS PRODUCTS.

SERVICE AGREEMENTS. Please contact your Polycom Authorized Reseller for information about service agreements applicable to your product.

SOFTWARE SUPPORT. Polycom will provide support for software running on the Product if all of the following conditions are satisfied:

- The product is under warranty or is covered by a Polycom service contract.
- The product software is the current major version or the next preceding major version (software revisions are labeled as "x.y.z," with the first two digits designating major versions).
- The product software comes with 90-day software warranty, providing for software updates (minor releases/bug fixes). To continue to receive support,

SAFETY AND REGULATORY INFORMATION. This device complies with Part 15 of the FCC Rules. Operation is subject to the following two conditions:

- (1) This device may not cause harmful interference, and
- (2) This device must accept any interferences received, including interference that may cause undesired operation.

NOTE: This equipment has been tested and found to comply with the limits for a Class A digital device, pursuant to part 15 of the FCC Rules. These limits are designed to provide reasonable protection against harmful interference when the equipment is operated in a commercial environment. This equipment generates, uses, and can radiate radio frequency energy and, if not installed and used in accordance with the instruction manual, may cause harmful interference to radio communications. Operation of this equipment in a residential area is likely to cause harmful interference in which case the user will be required to correct the interference at his own expense.

Hereby, Polycom, Inc. declares that the products in this manual are CE marked and in compliance with all EU directives and regulations that apply to them including: LVD & EMC Directives 2014/35/EC & 2014/30/EC. A full copy of the Declaration of Conformity can be obtained from Polycom Ltd., 270 Bath Road, Slough, Berkshire, SL1 4DX, UK.

In accordance with Part 15 of the FCC Rules, the user is cautioned that any changes or modifications not expressly approved by Polycom, Inc. could void the user's authority to operate the equipment.

Operating Ambient Conditions:

- Operating temperature: +32 to 104°F (0 to 40°C);
 - Relative humidity: 5% to 95%, noncondensing;
 - Storage temperature: -40 to +150°F (-40 to +70°C).
- Installation must be performed in accordance with all relevant national wiring rules.

L'installation doit être exécutée conformément à tous les règlements nationaux applicables au filage électrique.

The outlet to which this apparatus is connected must be installed near the equipment and must always be readily accessible.

La prise électrique à laquelle l'appareil est branché doit être installée près de l'équipement et doit toujours être facilement accessible.

This Class [A] digital apparatus complies with Canadian ICES-003.

Cet appareil numérique de la classe [A] sera conforme à la norme NMB-003 du Canada.

... purchasing a maintenance contract is the most economical solution.

Requests for software support should be made through the Polycom Reseller from whom the product was purchased.

LIMITATION OF LIABILITY. TO THE FULL EXTENT ALLOWED BY LAW, POLYCOM EXCLUDES FOR ITSELF AND ITS SUPPLIERS ANY LIABILITY, WHETHER BASED IN CONTRACT OR TORT (INCLUDING NEGLIGENCE), FOR INCIDENTAL, CONSEQUENTIAL, INDIRECT, SPECIAL, OR PUNITIVE DAMAGES OF ANY KIND, OR FOR LOSS OF REVENUE OR PROFITS, LOSS OF BUSINESS, LOSS OF INFORMATION OR DATA, OR OTHER FINANCIAL LOSS ARISING OUT OF OR IN CONNECTION WITH THE SALE, INSTALLATION, MAINTENANCE, USE, PERFORMANCE, FAILURE, OR INTERRUPTION OF ITS PRODUCTS, EVEN IF POLYCOM OR ITS AUTHORIZED RESELLER HAS BEEN ADVISED OF THE POSSIBILITY OF SUCH DAMAGES, AND LIMITS ITS LIABILITY TO REPAIR, REPLACEMENT, OR REFUND OF THE PURCHASE PRICE PAID, AT POLYCOM'S OPTION. THIS DISCLAIMER OF LIABILITY FOR DAMAGES WILL NOT BE AFFECTED IF ANY REMEDY PROVIDED HEREIN SHALL FAIL OF ITS ESSENTIAL PURPOSE.

DISCLAIMER. Some countries, states, or provinces do not allow the exclusion or limitation of implied warranties or the limitation of incidental or consequential damages for certain products supplied to consumers, or the limitation of liability for personal injury, so the above limitations and exclusions may be limited in their application to you. When the implied warranties are not allowed to be excluded in their entirety, they will be limited to the duration of the applicable written warranty. This warranty gives you specific legal rights which may vary depending on local law.

GOVERNING LAW. This Limited Warranty and Limitation of Liability shall be governed by the laws of the State of California, U.S.A., and by the laws of the United States, excluding their conflicts of laws principles. The United Nations Convention on Contracts for the International Sale of Goods is hereby excluded in its entirety from application to this Limited Warranty and Limitation of Liability. All rights reserved under International and Pan American Copyright Conventions. No part of the contents of this manual may be copied, reproduced, or transmitted in any form or by any means, or translated into another language or format, in whole or part, without written consent from Polycom, Inc. Do not remove (or allow anybody else to remove) any product identification, copyright or other notices. Polycom, the Polycom logo design, and Polycom VVX Expansion Module and Polycom VVX Core Expansion Module are trademarks of Polycom, Inc. in the U.S. and various other countries.

COPYRIGHT. All rights reserved under International and Pan-American Copyright Conventions. No part of the contents of this manual may be copied, reproduced, or transmitted in any form or by any means, or translated into another language or format, in whole or part, without written consent of Polycom, Inc. Polycom® and the logo design are registered trademarks and Polycom VVX Expansion Module and Polycom VVX Core Expansion Module are trademarks of Polycom, Inc. in the United States, and various countries. Do not remove (or allow any third party to remove) any product identification, copyright or other notices.

To avoid electric shock, do not connect safety extra low voltage (SELV) circuits to teleconference station network (TNV) circuits. LAN ports contain SELV circuit, and WAN ports contain TNV circuits. Some LAN and WAN ports both use RJ-45 connectors. Use caution when connecting cables. This product is rated 48Vdc, 0.38A.

Afin d'éviter les chocs électriques, ne pas connecter de circuits de tension extra-basse de sécurité (SELV) à des circuits de réseau de stations de téléconférence (TNV). Les ports LAN contiennent un circuit SELV et les ports WAN contiennent des circuits TNV. Certains ports LAN et WAN utilisent tous deux des connecteurs RJ-45. Faites preuve de prudence lors de la connexion des câbles. Ce produit a les caractéristiques suivantes : 48 Vdc, 0,38 A. In addition, all PoE sources must meet the Limited Power Source requirements of IEC 60950-1:2005 (2nd Edition); Am1:2009 or IEC 60950-1:2005 (2nd Edition); Am1:2009; Am2:2013. En outre, toutes les sources PoE doivent satisfaire aux exigences de source d'alimentation limitée de la IEC 60950-1:2005 (2ème édition); Am1:2009 ou IEC 60950-1:2005 (2ème édition); Am1:2009; Am2:2013.

Japan:

この装置は、クラスA情報技術装置です。この装置を家庭環境で使用すると電波妨害を引き起こすことがあります。この場合には使用者が適切な対策を講ずるよう要求されることがあります。 VCCI-A

Contact Information:

Please contact your Polycom Authorized Reseller for assistance.

<http://www.polycom.com>



1725-49101-001E